

LOW VISION AIDS CATALOGUE

<http://www.jhoptical.com/Low-Vision.html>

Come to website to view more products



1582
6X30mm



1584
6X25mm



1586
6X30mm



1587
8X21mm



1587D
7X21mm



1587S
7X21mm



1588
10X15mm



1588D
10X15mm



6501
10X20mm



6502
10X20mm



6503
10X20mm



6504
10X25mm



6701
2X 4X/100X50mm



6763
3.5X/40X30



6764
3X/42X42



6765
2X/42X42



6721
4X35mm



6722
6X35mm



6723
8X30mm



6724
10X30mm



6731 2X 4X/90 6732 2.5X 5X/84 6733 3X 6X/70 6734 3.5X 7X/60 6735 4X 8X/50



6736/16D 5X35mm 6736/20D 6X35mm 6736/24D 7X35mm 6736/28D 8X35mm 6736/32D 9X35mm



6741 2X/100X50 6742 100X2X 6743 80X2.5X 6744 60X3X 6745 50X4X



6771 1.8X112mm 6772 2X92mm 6773 3X72mm 6774 4X52mm



6714 8X35mm 6715 10X35mm 6716 12X30mm 6717 14X30mm 6714L 8X35mm 6715L 10X35mm 6716L 12X30mm 6717L 14X30mm



7811 4X50 7812 7X50 7813 8X35 7814 10X35 7815 12X30 7816 14X30



7821 2.5X/40X35 7822 4X/40X35 7823 6X/40X35



7841 3X/45X50 7842 5X/45X50



7831 (带LED灯 With LED Lamp) 2X4X/2X90



7833 (带LED灯 With LED Lamp) 3X6X/3X70



6512
10X30mm



6514
5X30mm



6513 (带分划板 With Reticle)
8X30mm

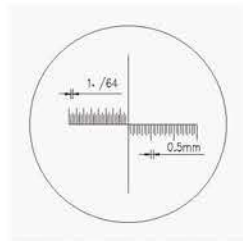

6513-F1
8X30mm



6513-F2
8X30mm

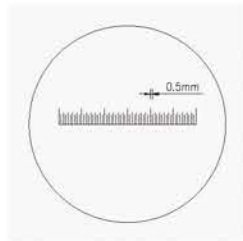

6513-F3
8X30mm



6906
7X50mm



6907
8X35mm



7852 (带LED灯 With LED Lamp)
2.5X80mm



7853 (带LED灯 With LED Lamp)
3X60mm



7854 (可充电式LED照明 With LED Lamp)
2.8X/110X60



6755
7X50mm



6756
8X35mm



6757
10X35mm



6758
12X30mm



6759
14X30mm



6801
8X30mm



6802
8X30mm



8501
5X29mm

8502
7X29mm

8503
9X29mm



8504
12X

8505
15X



7711
2X/142X110



7721
2X/142X110



6803 (带分划板 With Reticle)
8X30mm



6804 (带分划板 With Reticle)
2X100mm

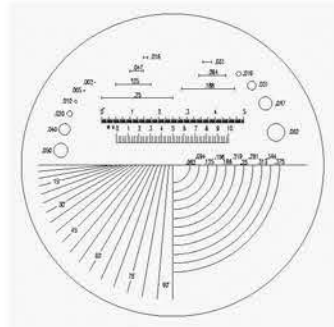

6803-F1
6804-F1

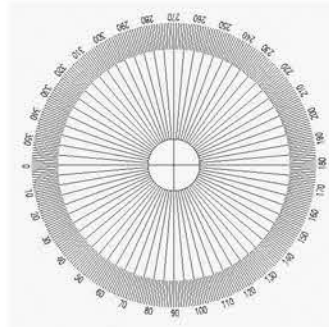

6803-F2
6804-F2

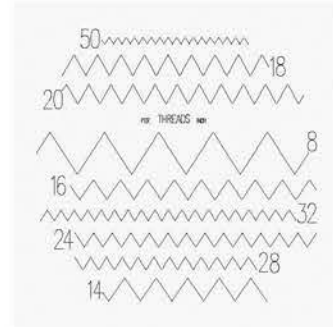

6803-F3
6804-F3

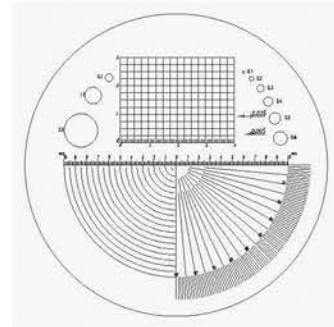

6803-F4
6804-F4

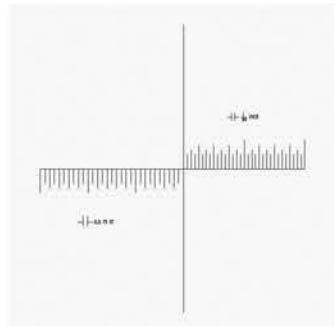

6803-F5
6804-F5

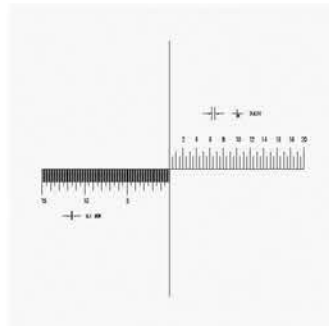

6803-F6
6804-F6

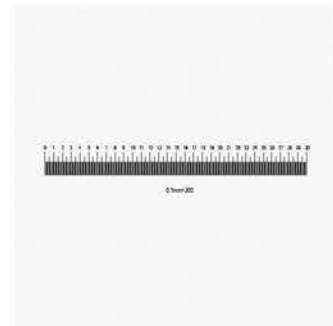

6803-F7
6804-F7

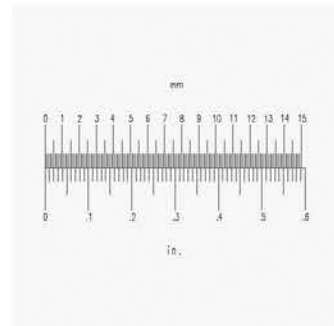

6803-F8
6804-F8



8011 (带分划板 With Reticle)
10X21mm



8012 (带分划板 With Reticle)
9X16mm



8012A (带分划板 With Reticle)
9X16mm



8013 (带分划板 With Reticle)
7X25mm



8014 (带分划板 With Reticle)
10X19mm

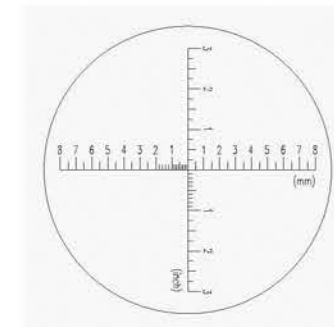

8013-F1
8014-F1

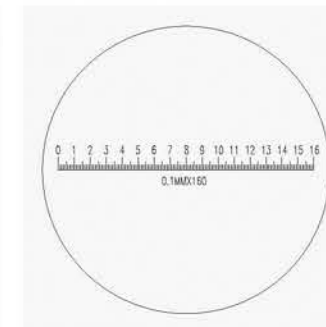

8013-F2
8014-F2

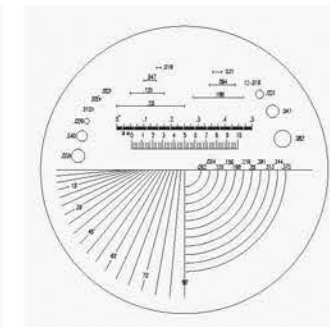

8013-F3
8014-F3

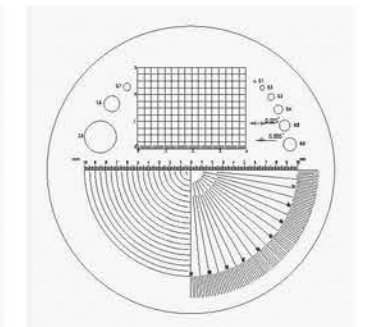

8013-F4
8014-F4



6909 3X115mm 6910 3X95mm 6911 4X80mm 6912 4X65mm 6913 4X50mm



7861
5X90mm



7722
2.8X/110X60



7512
5X152mm

7513
5X200mm

7514
5X250mm

7512B、7513B、7514B

B表示带有标尺
B stands for inside separation line



8001
14X14mm



8021
10X15mm

8022
15X16mm

8023
20X13mm



7401 (排卵期检测镜 Ovulation scope)



7601
2X 4X/2X110



7601L (带LED灯 With LED Lamp)
2X 4X/2X110



1102
5X30mm



1102A
5X30mm



1103
2X ~ 15X/3.5"屏 (3.5" Screen)



1104
5X ~ 25X/4.3"屏 (4.3" Screen)



8101
3X24



8102
2.8X28



8104
16X23



8102A
2.8X28



8108
16X23



8541
2.5X25mm



8105
2X35

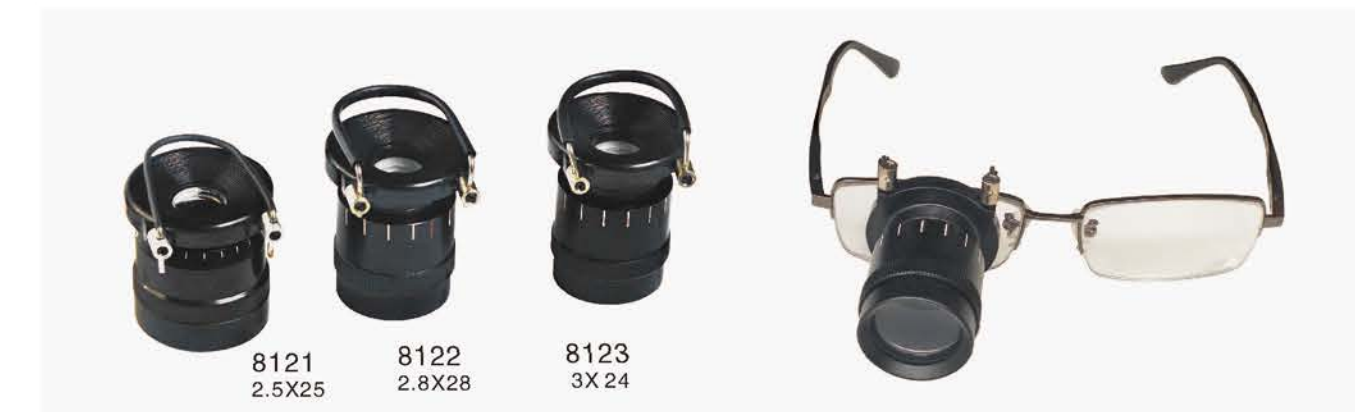

8121
2.5X25

8122
2.8X28

8123
3X24



8521
2.5X25



8522
3X25



8530 (八件装 eight-piece set)
75X28 (1.5X, 1.75X, 2X, 2.25X, 2.5X, 2.75X, 3X, 3.5X)



8106
2X35



8510 (四件装 four-piece set)
75X28 (1.5X, 2X, 2.5X, 3X)



8511
1.5X/75X28

8512
2X/75X28

8513
2.5X/75X28

8514
3X/75X28



8031
10X18.5



8032
12X17



8033
15X15



8041L
20X13

8042L
30X10

8043L
40X7



8044L
20X13

8045L
30X10

8046L
40X7



8300
25X



8301
40X



8302
60X



8303
80X



8304
100X



8201 (笔式显微镜 pen microscopes)
16X-40X/13X125



8121S
2.5X



8123S
3X



8124
2.5X24mm



8111
2.8X27

8112
4X12mm

8113
6X16mm

8114
8X21mm

8115
10X25mm



7901 (四件装 four-piece set)



7902 (七件装 seven-piece set)



CERTIFICATE of Conformity

Reference No. : LCS180727007AR

Applicant : SHANGHAI JIAHUI OPTICAL INSTRUMENT CO., LTD

Address : RM316, SHIWAN NO.7 ROAD, PUDONG AREA, SHANGHAI, CHINA

Sample Name : MAGNIFIERS

Trade Mark : N/A

Test Item No. : 6742

6743, 6744, 6745, 6772, 6773, 6774, 7821, 7822, 7823, 7841, 7842,
7512, 7512B, 7513, 7513B, 7514, 7514B, 8510, 8511, 8512, 8513, 8514,
Style/ Item No. : 6763, 6764, 6765, 8501, 8502, 8503, 8504, 8505, 6909, 6910, 6911,
6912, 6913, 8111, 8112, 8113, 8114, 8115, 8121, 8122, 8123, 8121S,
8122S, 8123S

The submitted products have been tested by us with the listed standards and found in compliance with the following European Directives:

The RoHS Directive 2011/65/EU

IEC 62321-3-1:2013 IEC 62321-5:2013 IEC 62321-4:2013+AMD1:2017 CSV
IEC 62321-6:2015 IEC 62321-7-1:2015 IEC 62321-7-2:2017

The tests were performed in normal operation mode. The test results apply only to the particular sample tested and to the specific tests carried out. This certificate applies specifically to the sample investigated in our test reference number only.

The RoHS markings as shown below can be affixed on the product after preparation of necessary technical documentation.

Other relevant Directives have to be observed.

RoHS

Date of issue: August 07, 2018



Shenzhen LCS Compliance Testing Laboratory Ltd.
Unit F-3, Floor 23, Kechuang Building, Quanzhi Innovation Science and Technology Park, Shajing Town,
Bao'an District, Shenzhen, Guangdong, China
Tel: (86)755-23353209 [Http://www.lcs-cert.com](http://www.lcs-cert.com) Email: webmaster@lcs-cert.com

